

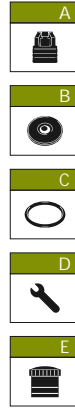

AR 30

335 AR 30 AP C/SP - NBR

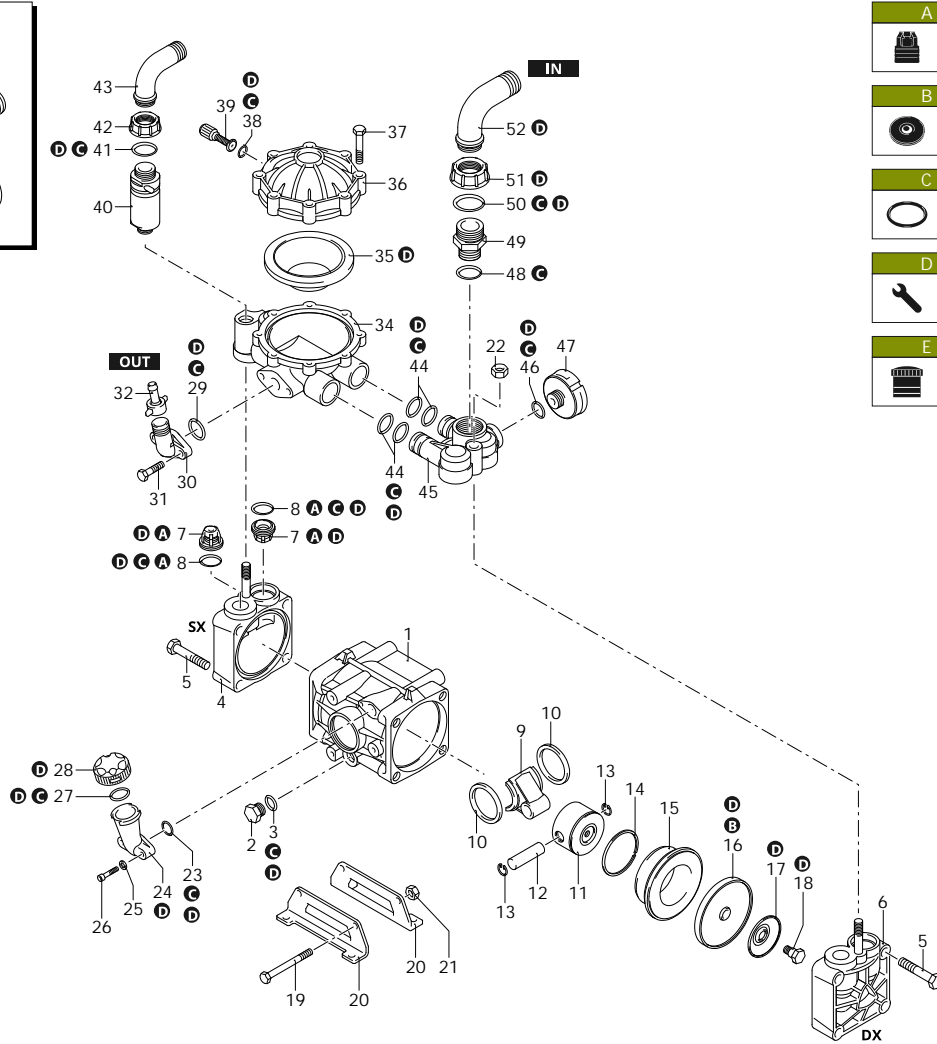
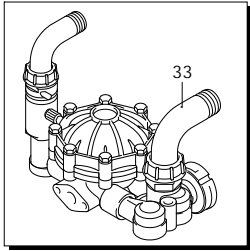

Code	Description	Q	Note	Validity
1	620011 Pump body		1	
2	880530 Plug	3/8" G	1 C=20Nm	
3	740290 O-ring	Ø 14x1,78	1 Lubricate Molykote PG54	
4	620102 Head	dx	1	
5	621430 Screw	TE M12x55	8 C=50Nm	
6	620101 Head	dx	1	
7	629050 Valve		4	
8	620030 O-ring	Ø 25,80x3,53	4 Lubricate with motor oil	
9	620140 Connecting-rod		2 Lubricate with motor oil	
10	580470 Ring	Connecting-rod	4 Lubricate with motor oil	
11	620120 Piston	Ø 56	2	
12	380300 Pin		2 Lubricate with Mineral Grease	
13	380080 Ring	seeger Øi 14	4	
14	160230 Piston ring		2	
15	620110 Sleeve		2	
16	620080 Diaphragm	NBR - Øe 96	2	
17	1040180 Plate		2	
18	580360 Hub pin		2 C=20Nm / Molykote 1000	
19	380210 Screw	TE M8x75	2 C=30Nm	
20	380200 Foot		2	
21	380240 Nut	M8	2 C=10Nm	
22	180150 Nut	M10	2 C=40Nm	
23	180101 O-ring	Ø 17,5x2	1 Lubricate with motor oil	
24	550030 Tank		1	
25	550331 Washer		2	
26	850850 Screw	TCEI M6x30	2 C=10Nm	
27	550040 O-ring	Ø 26,65x2,62	1 Lubricate with motor oil	
28	550050 Plug	yellow	1	
29	550350 O-ring	Ø 23,81x2,62	1 Lubricate with Mineral Grease	
30	450145 Flange		1	
31	540290 Screw	TCEI M8x25	2 C=23Nm	
32	110130 Ring nut	1/2" G	1	
33	1522 Air chamber	NBR	1	
34	620180 Semi air chamber	lower	1	
35	550190 Diaphragm	NBR - Øe 110	1	
36	620230 Semi air chamber	upper	1	
37	621780 Screw	TE M8x40	8 C=10Nm / Molykote 1000	
38	650542 Gasket		1 Lubricate with motor oil	
39	180020 Air valve		1 C=3Nm / Loxeal 55-14	
40	1609001 Safety valve	40 bar	1 C=10Nm / Loxeal 24-18	
41	880831 O-ring	Ø 15,54x2,62 Viton	1 Lubricate Molykote G-807	
42	550450 Ring nut	3/4" G	1	
43	550460 Elbow	Ø 18	1	
44	390060 O-ring	Ø 20,63x2,62	4	
45	620150 Fitting		1	
46	180101 O-ring	Ø 17,5x2	1 Lubricate with motor oil	

AR_01_027_v01

Customer: AR
Customer Code:



Revision: 1
Date: 05/07/2024

Validity: < XX/YY = From week/year



AR 30

335 AR 30 AP C/SP - NBR

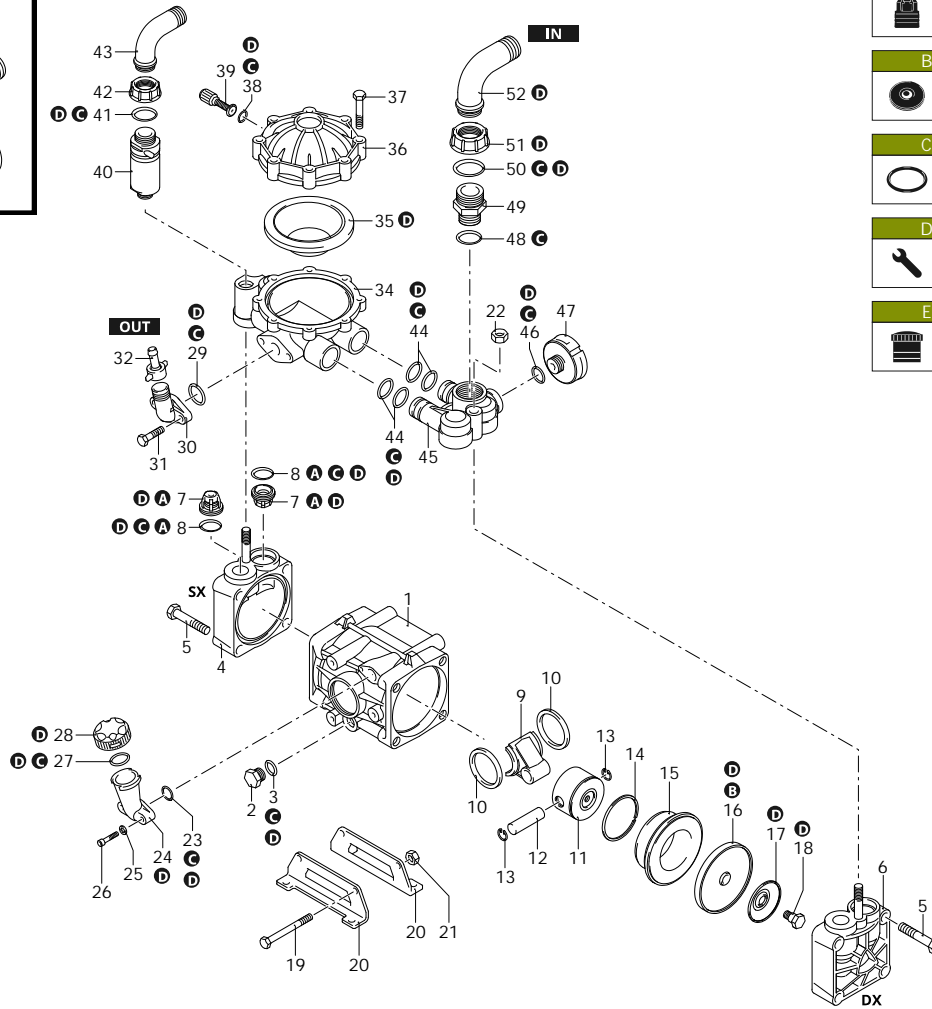
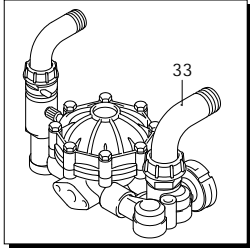

- A
- B
- C
- D
- E

Code	Description	Q	Note	Validity
47	659213 Diaphragm	1		
48	390290 O-ring	1	Ø 29x3	Lubricate Molykote PG54
49	550340 Fitting	1	1" G (M-M)	
50	550350 O-ring	1	Ø 23,81x2,62	Lubricate with Mineral Grease
51	550880 Ring nut	1	1" G	
52	550370 Elbow	1	Ø 25	
A	1917 Valve kit	1		
B	1930 Diaphragms kit	1	NBR	
C	1916 O-ring kit	1		
D	1915 Maintenance repair kit	1	NBR	
E	47194 Tank kit	1		

AR_01_027_v01

Customer: AR
Customer Code:



SAE 30
0,700 Kg

Revision: 1

Date: 05/07/2024

Validity: < XX/YY = From week/year



AR 30

335 AR 30 AP C/SP - NBR

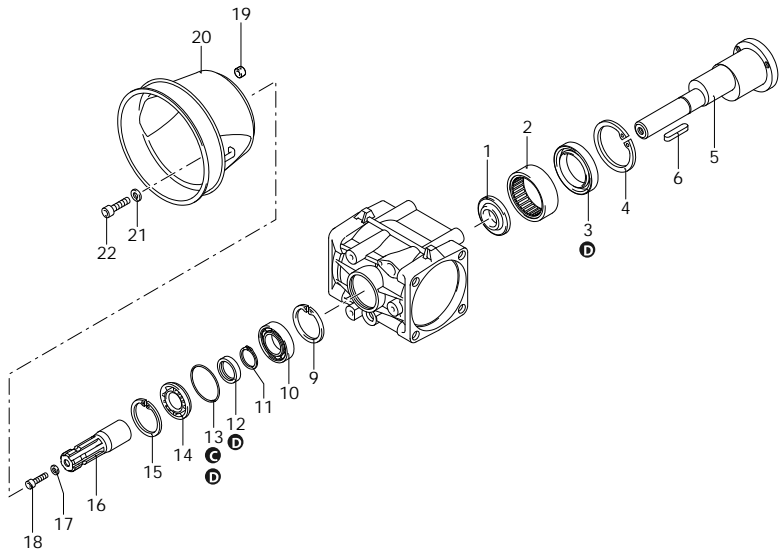
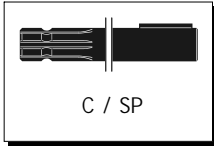

Code	Description	Q	Note	Validity
1	620160 Spacer		1	
2	550060 Bushing		1 Press Mount	
3	620130 Ring	seal	1 Lubricate with Mineral Grease	
4	620330 Ring	seeger Øi 65	1	
5	620172 Shaft	P marked	1	
6	620680 Key		1	
9	111120 Ring	seeger Øi 47	1	
10	620190 Bearing		1	
11	620291 Ring	seeger Øe 20	1	
12	620630 Ring	seal	1	
13	620210 O-ring	Ø 40,95x2,62	1	
14	620021 Cover		1	
15	111120 Ring	seeger Øi 47	1	
16	621370 Coupling		1 Spray Molykote D-321R	
17	961340 Washer		1	
18	680350 Screw	TCEI M8x35	1 C=10Nm	
19	1200521 Spacer		3	
20	1500350 Cardan protection	ø 199 mm	1	
21	380241 Washer		3	
22	680350 Screw	TCEI M8x35	3 C=10Nm	
A	1917 Valve kit		1	
B	1930 Diaphragms kit	NBR	1	
C	1916 O-ring kit		1	
D	1915 Maintenance repair kit	NBR	1	

AR_03_046_v01

Customer: AR
Customer Code:



SAE 30
0,700 Kg

Revision: 1

Date: 05/07/2024

Validity: < XX/YY = From week/year